

Fig. 1

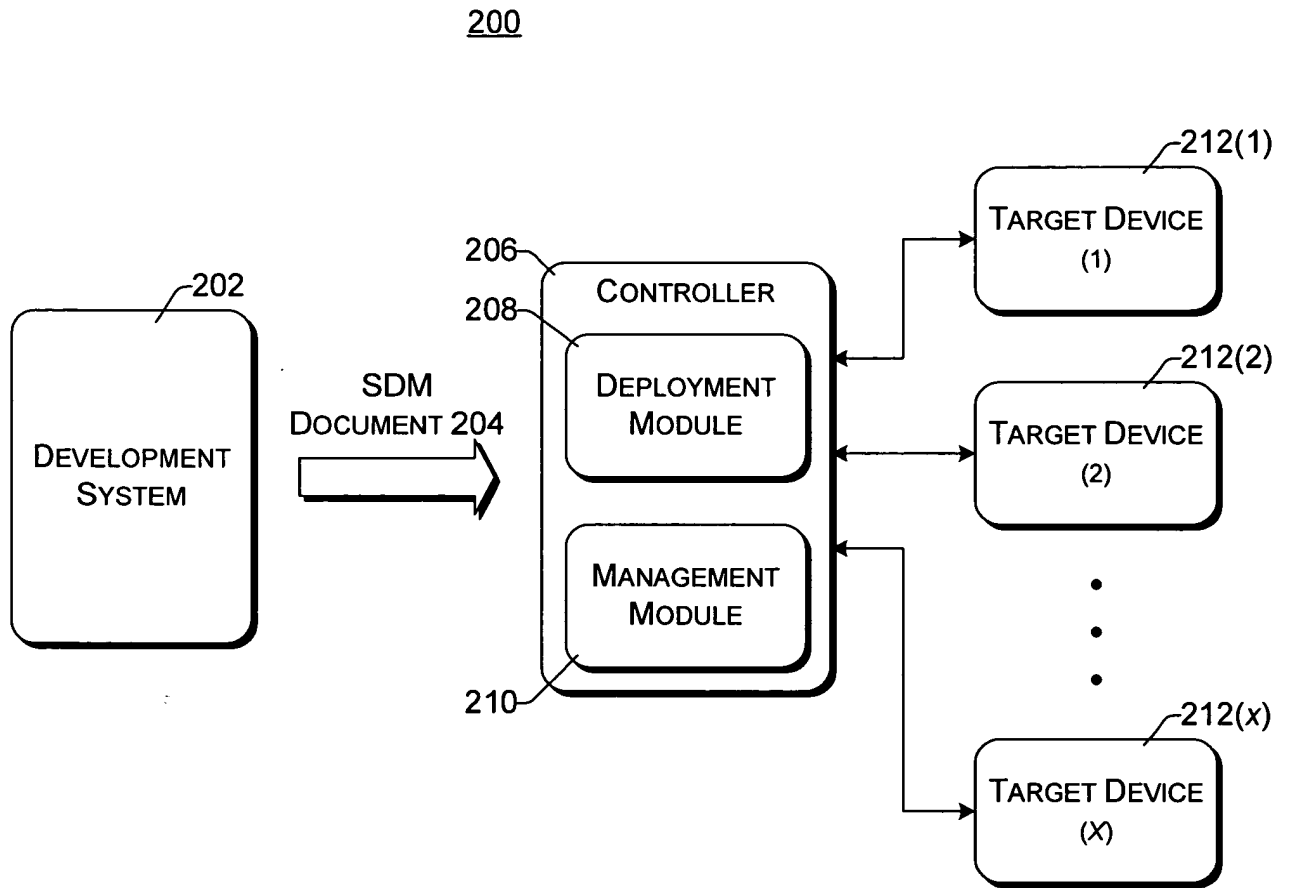

Fig. 2

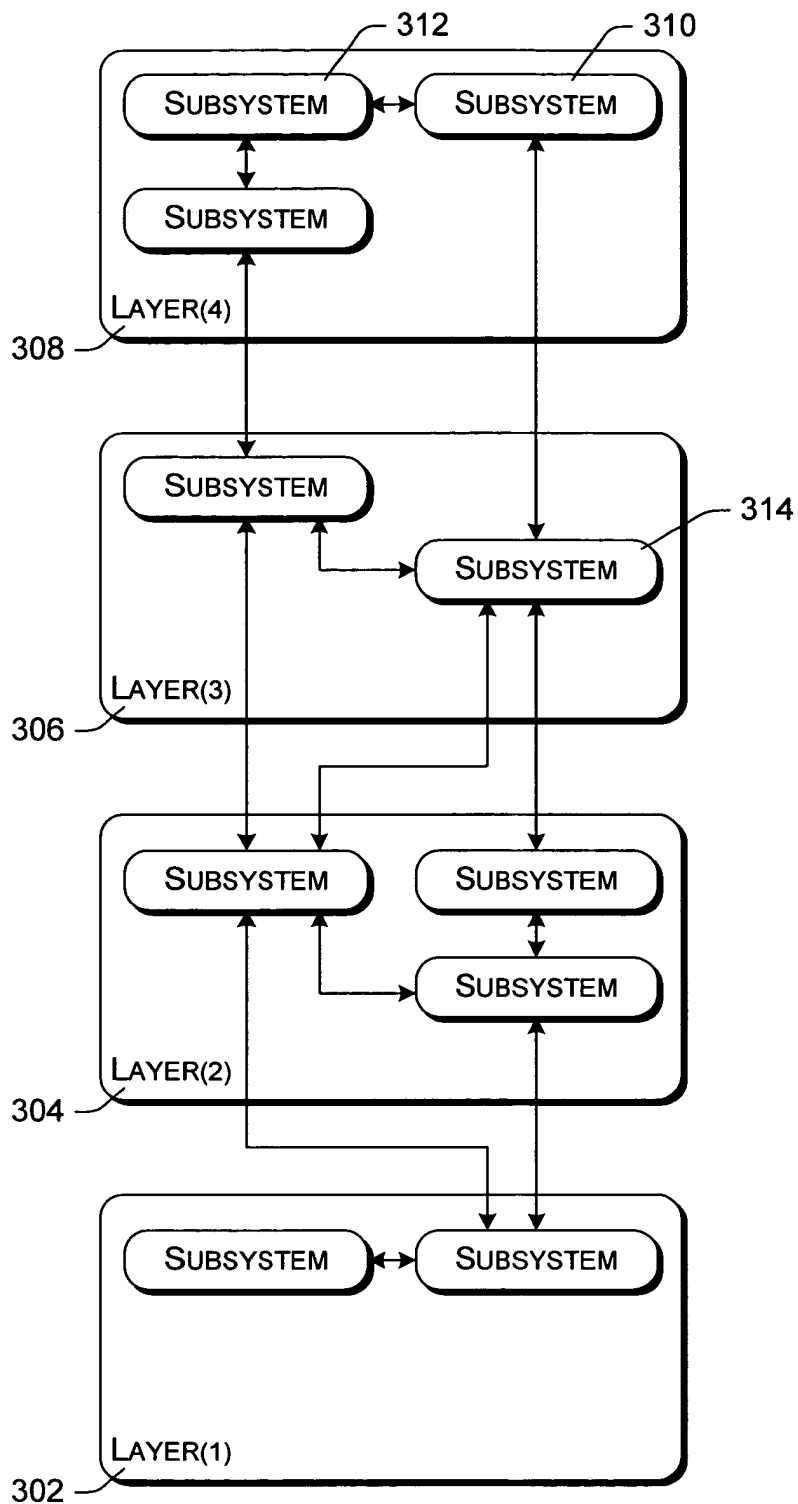

Fig. 3

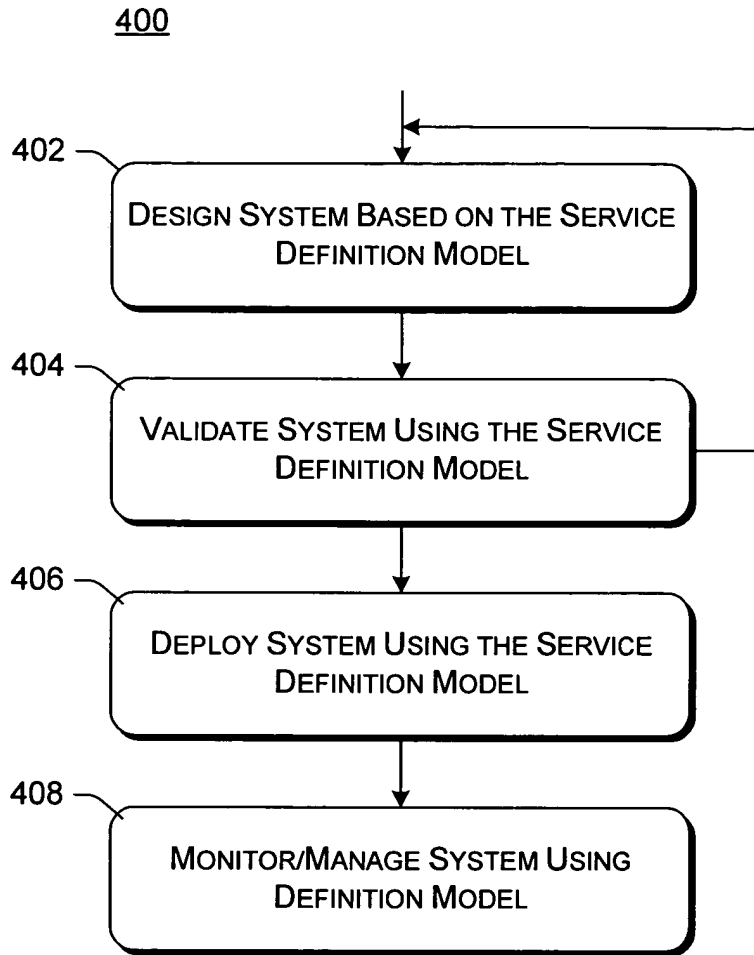
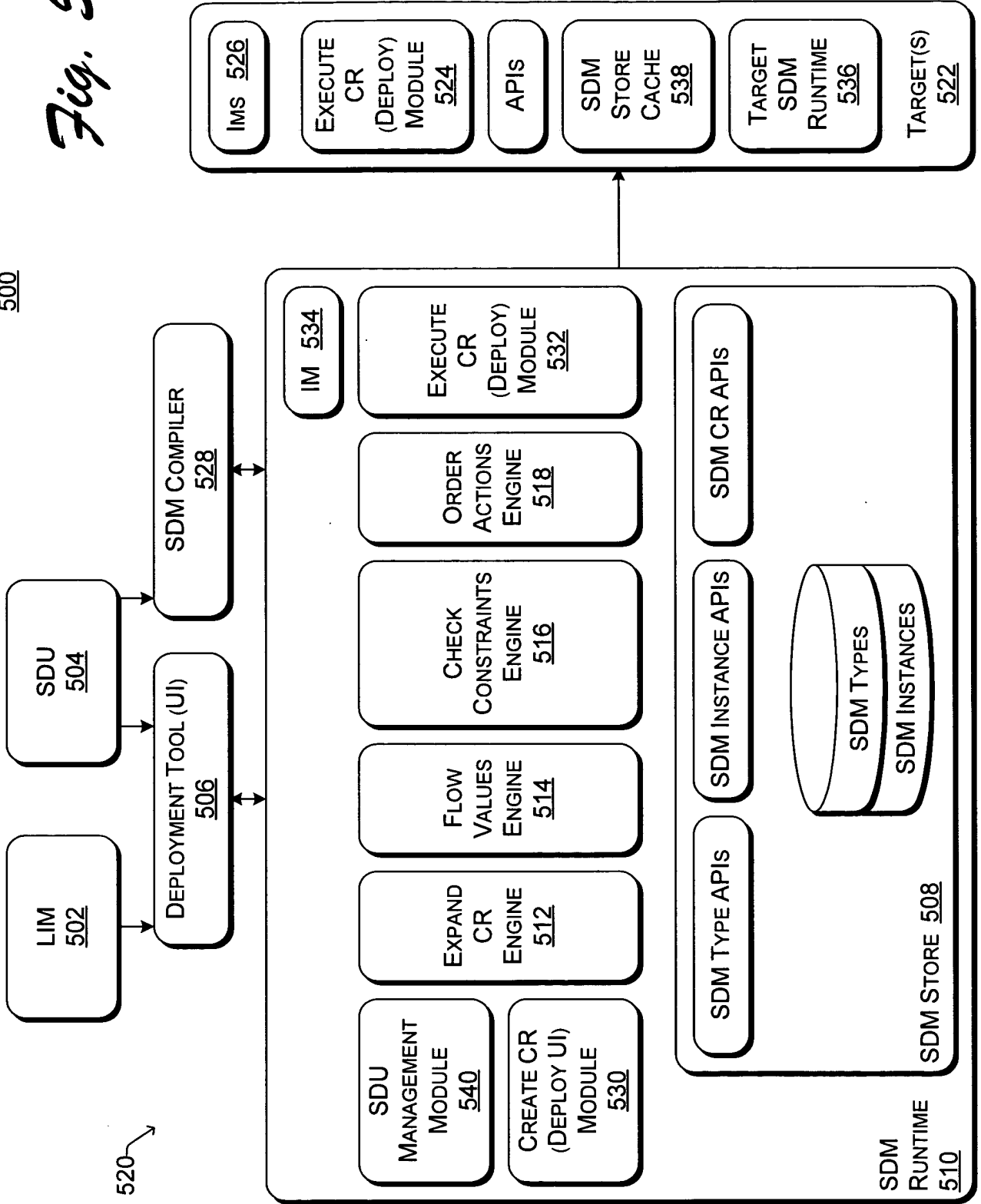

Fig. 4

Fig. 5

500



520

SDM
 RUNTIME
 510

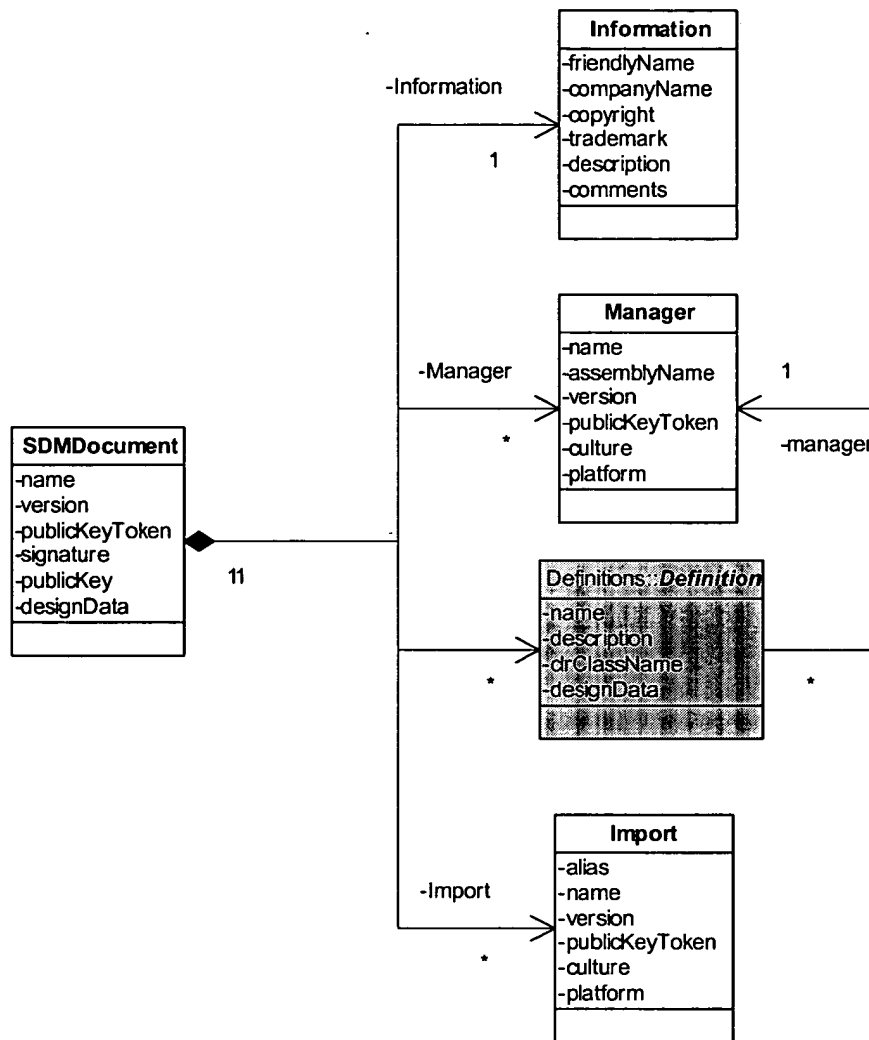

Fig. 6

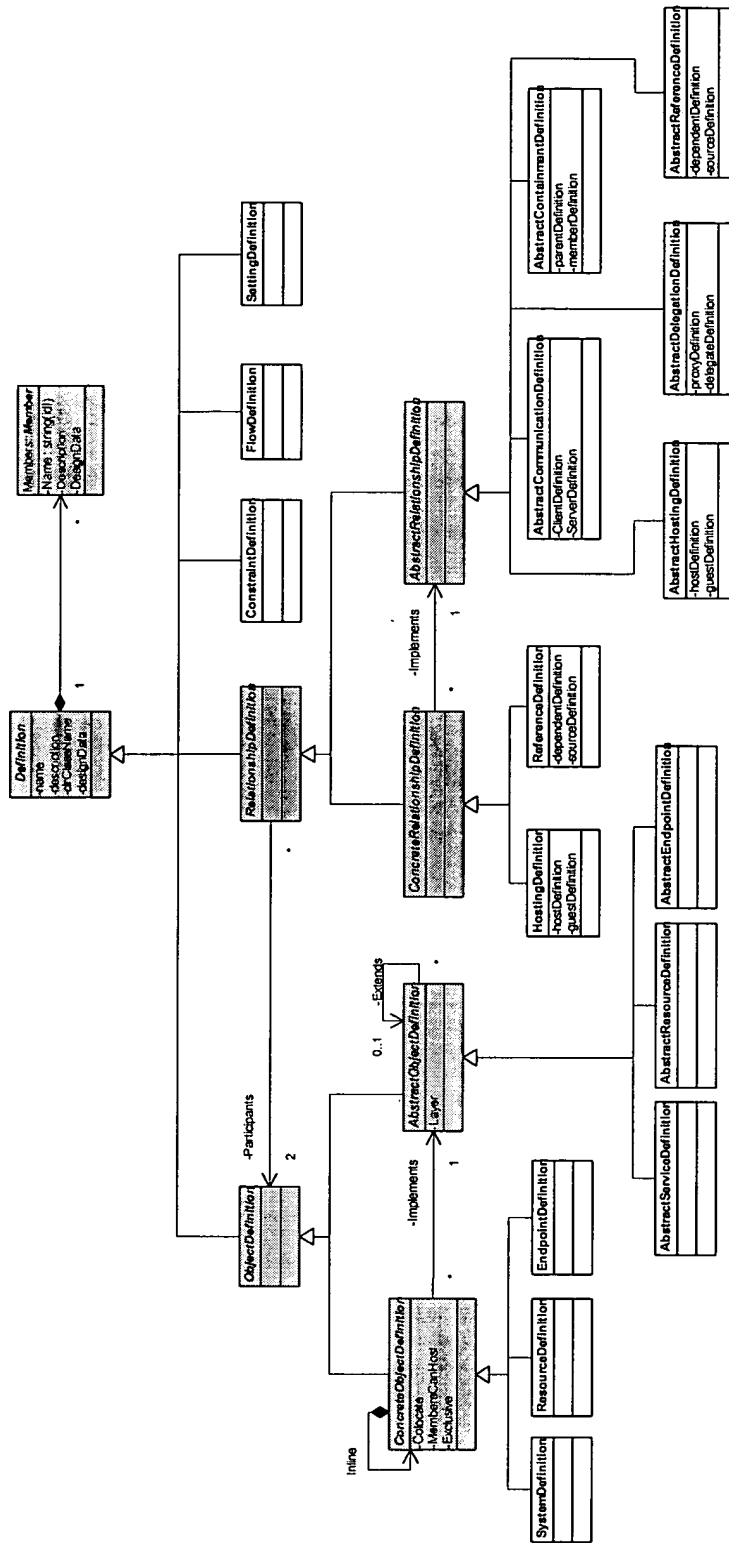

Fig. 7

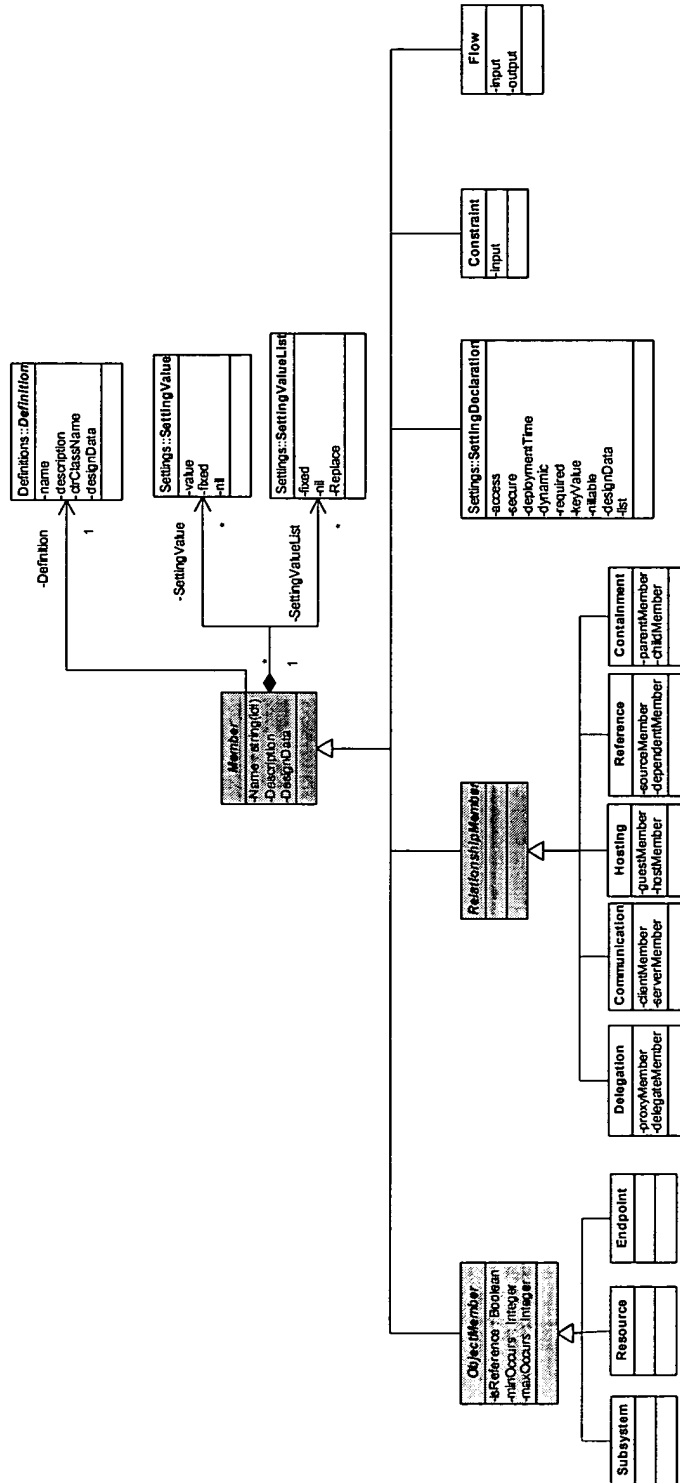

Fig. 8

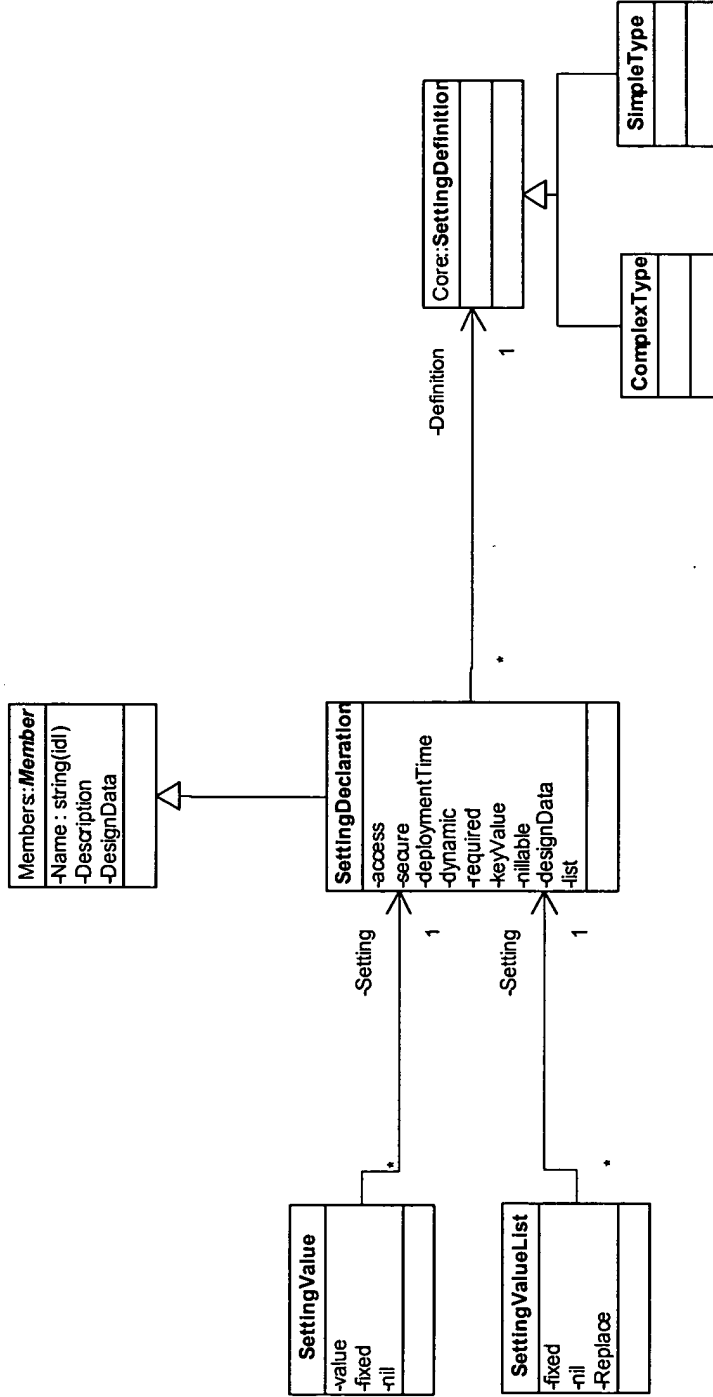

Fig. 9

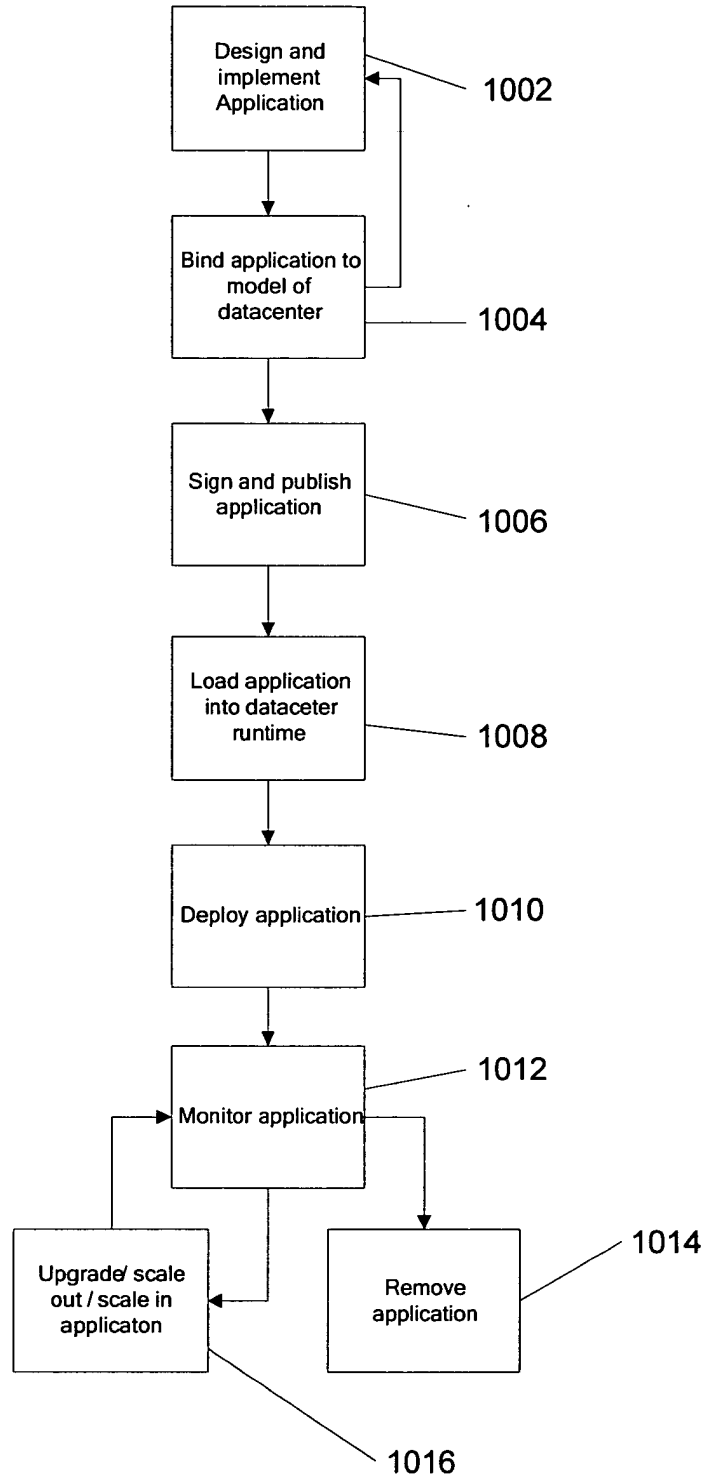
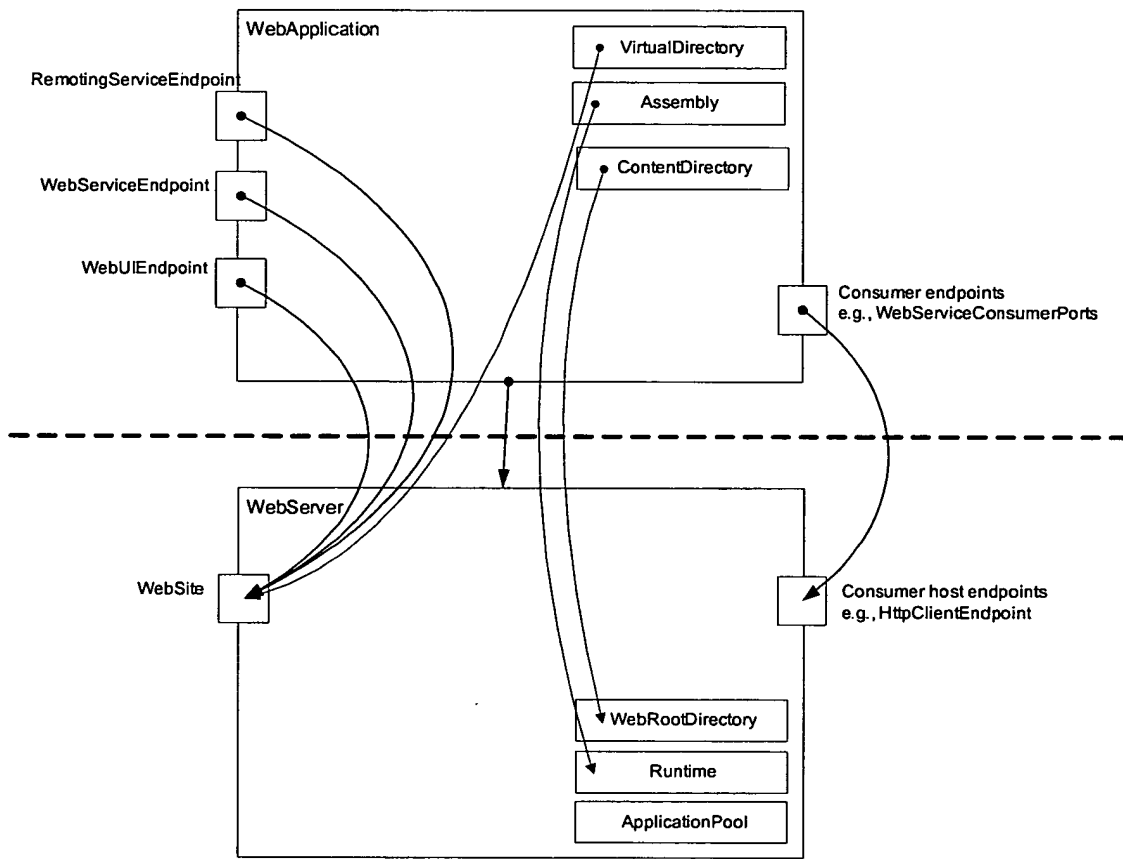

Fig. 10

ASP.NET v1.2 (Application Layer)



IIS v6.0 (Host Layer)

Fig. 11

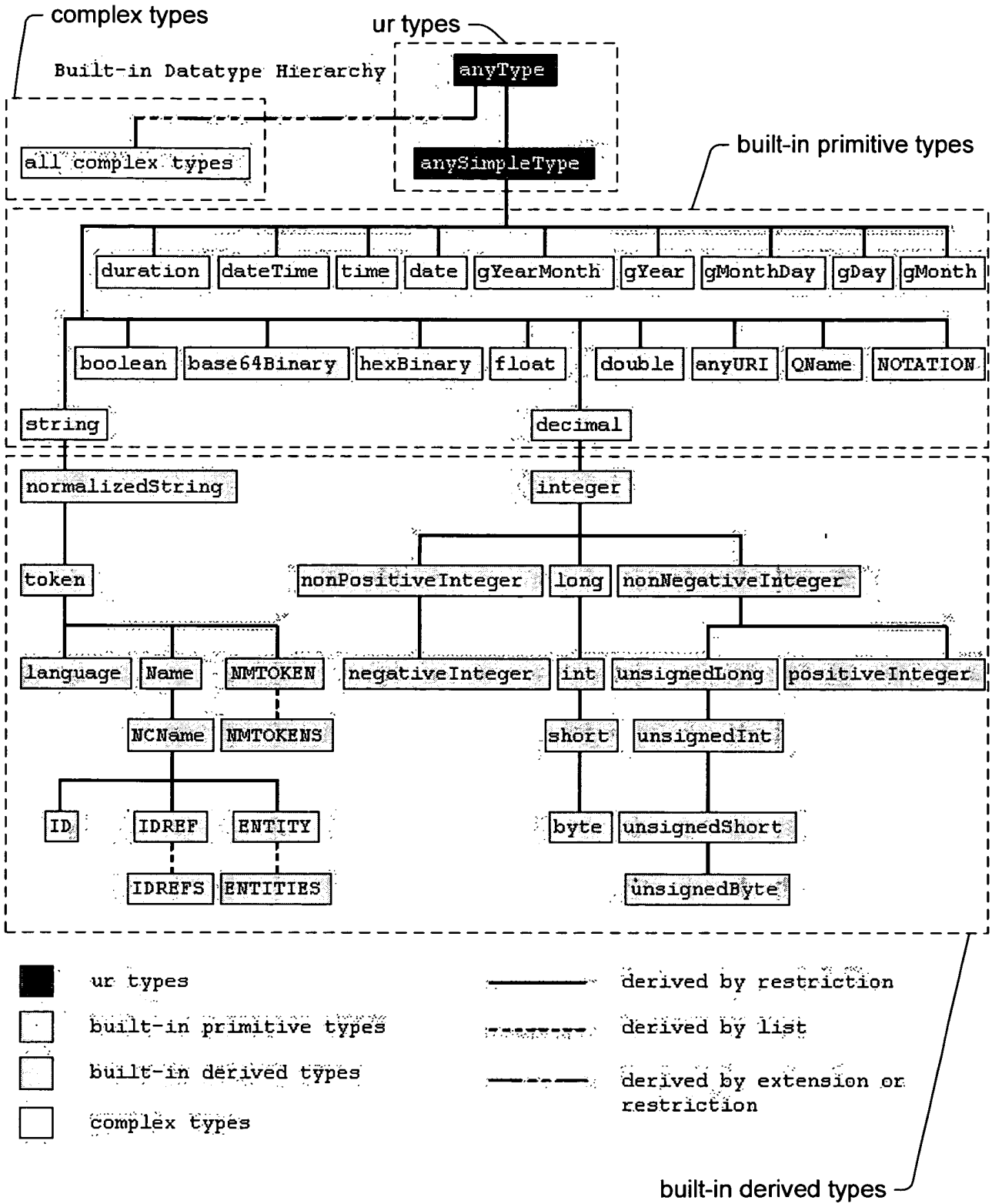

Fig. 12

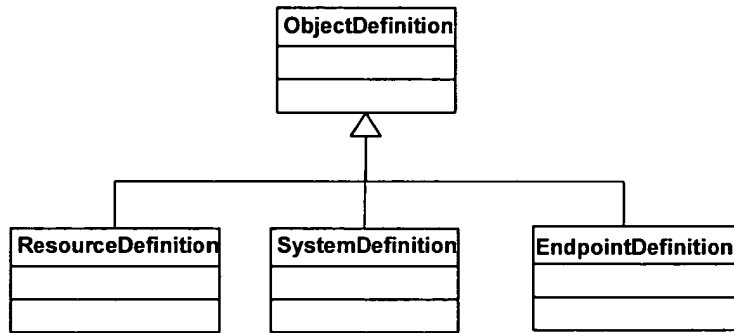

Fig. 13

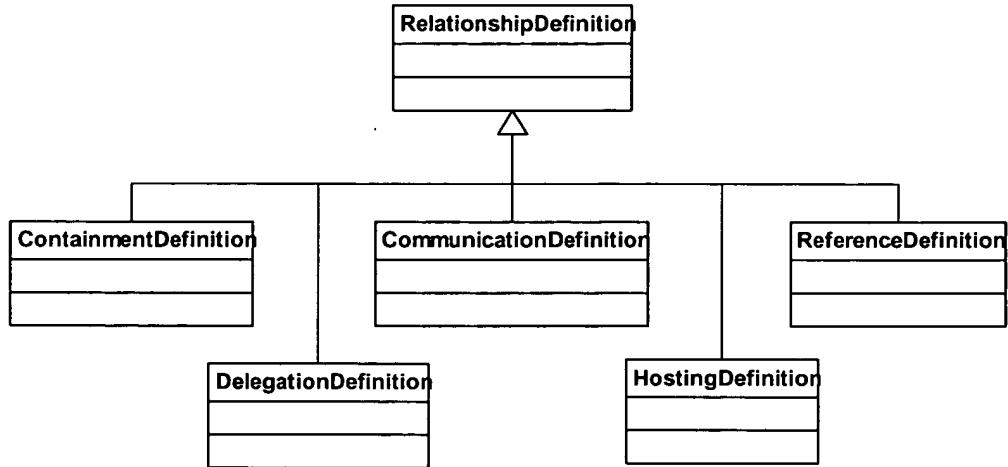

Fig. 14

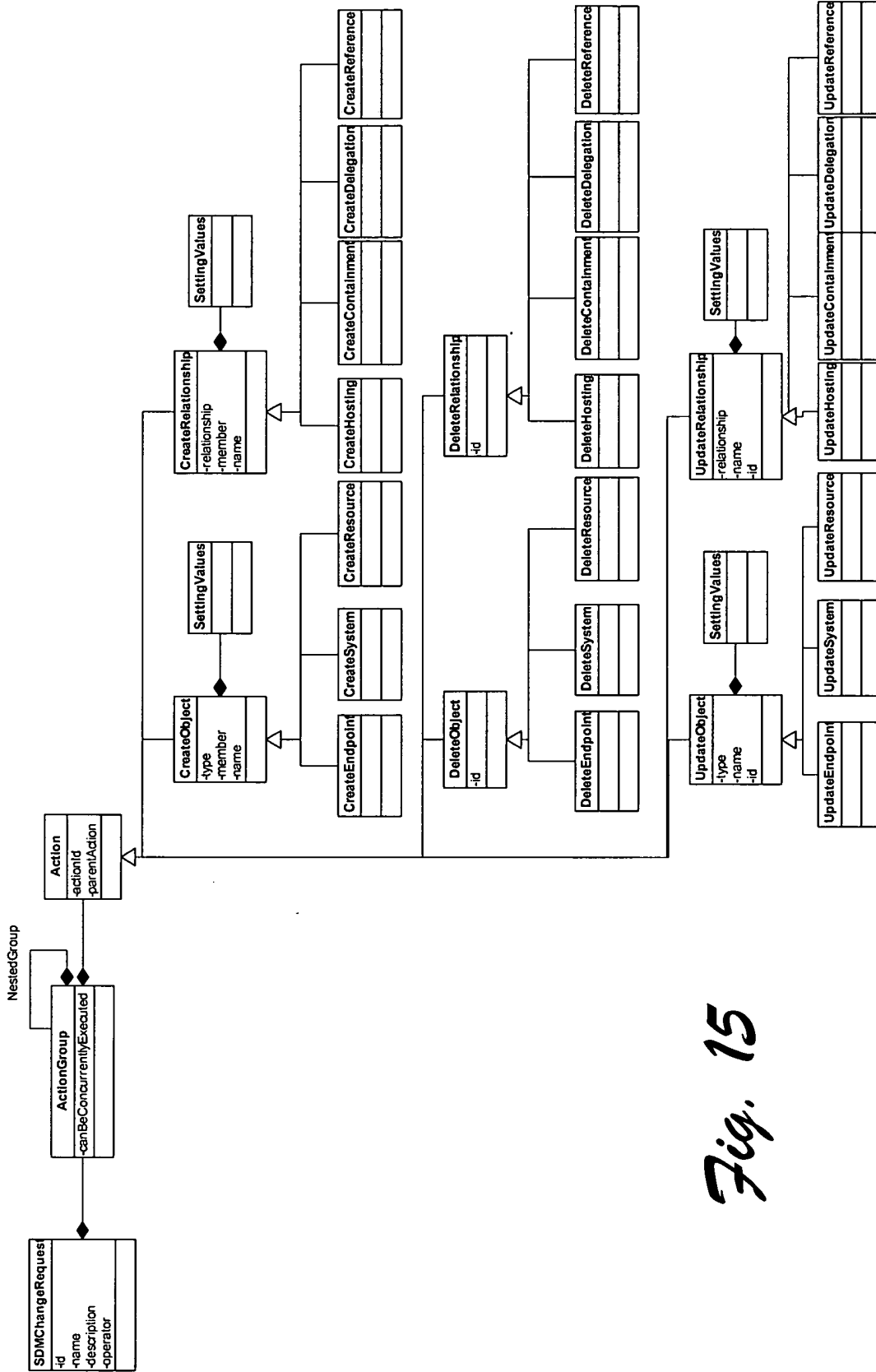

Fig. 15

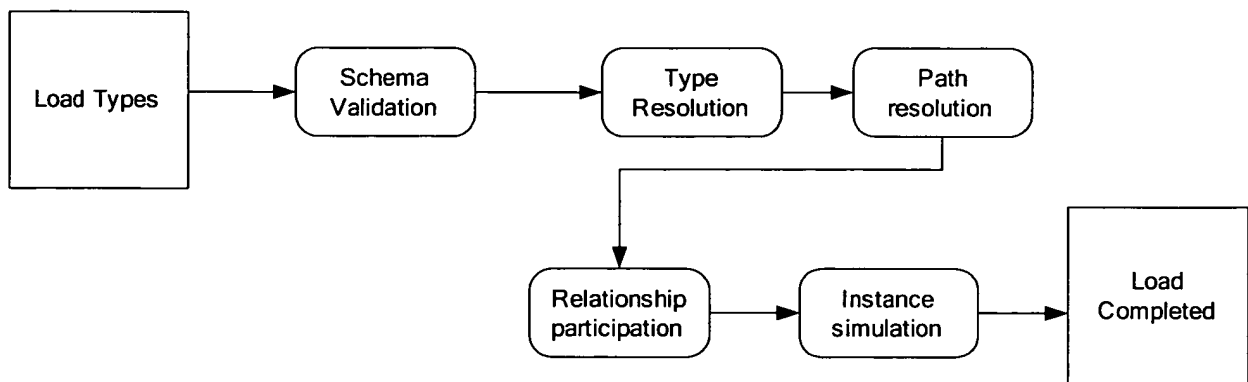

Fig. 16

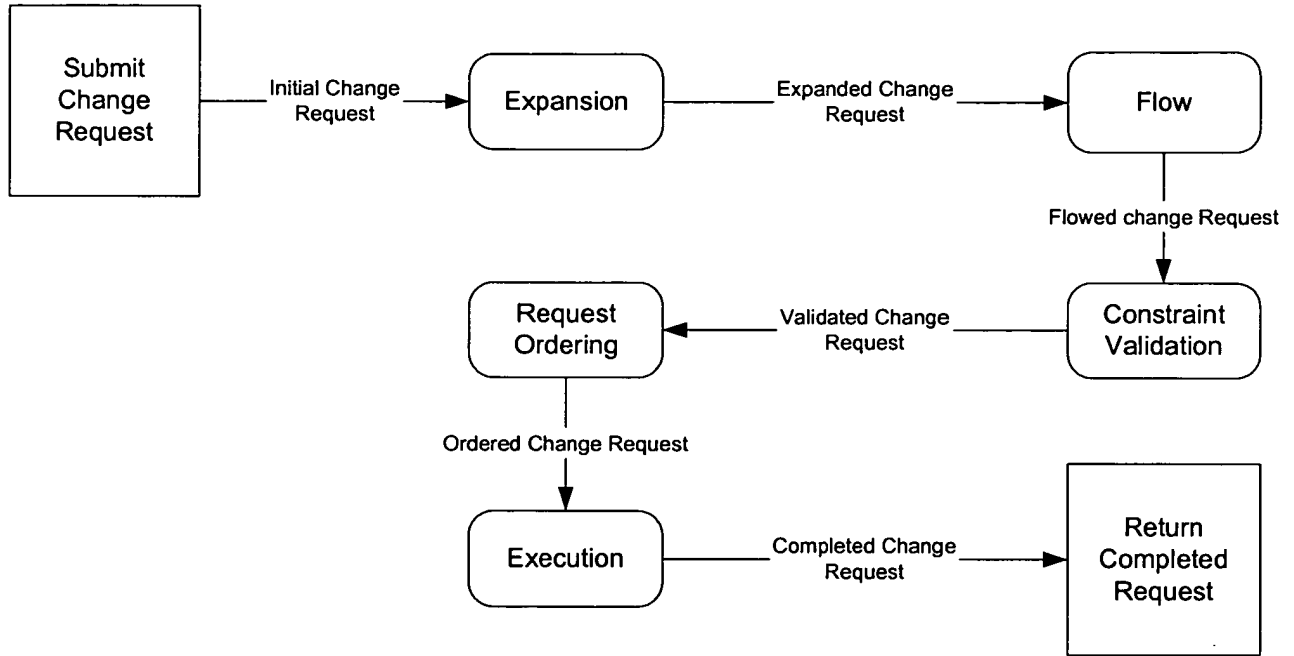

Fig. 17

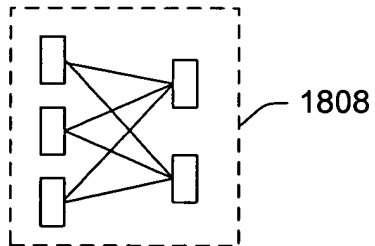
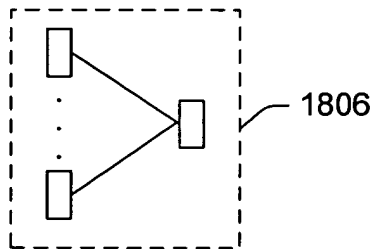
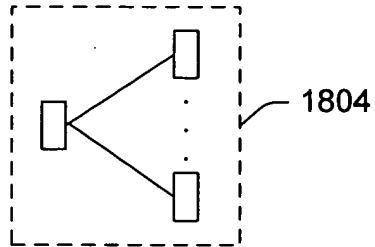
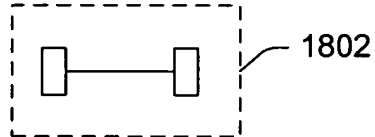
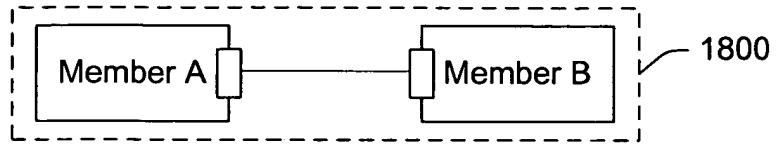

Fig. 18

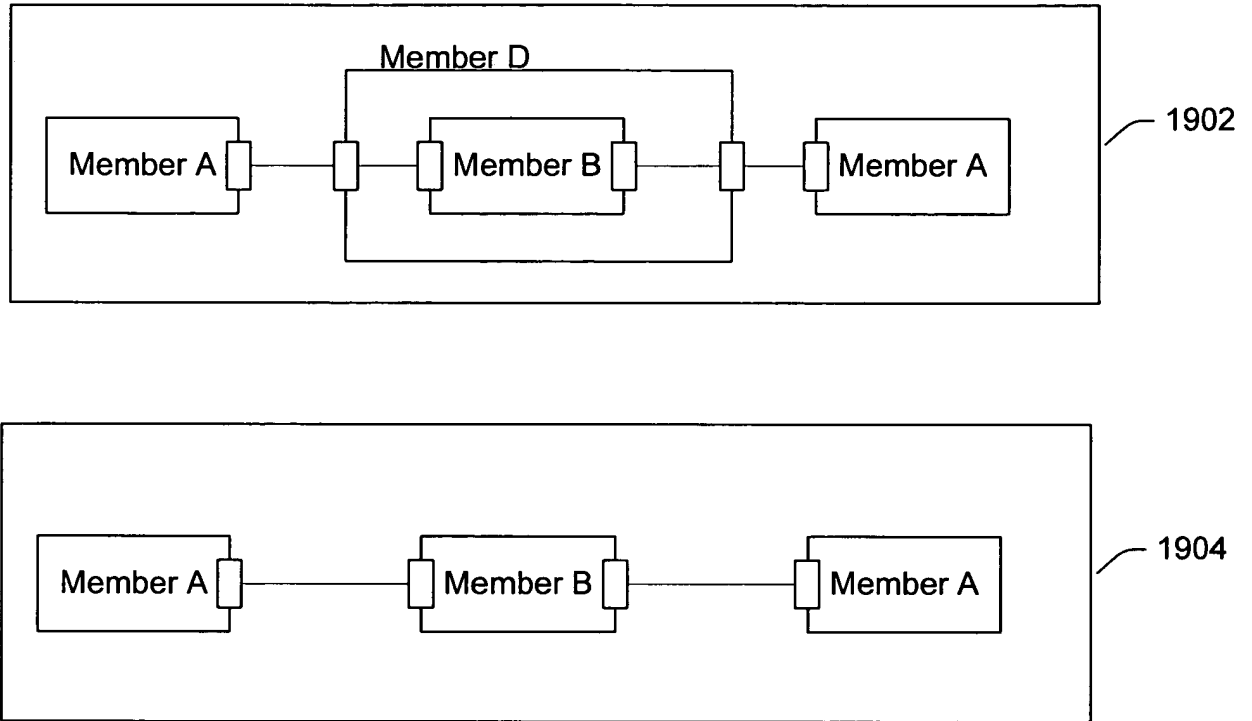

Fig. 19

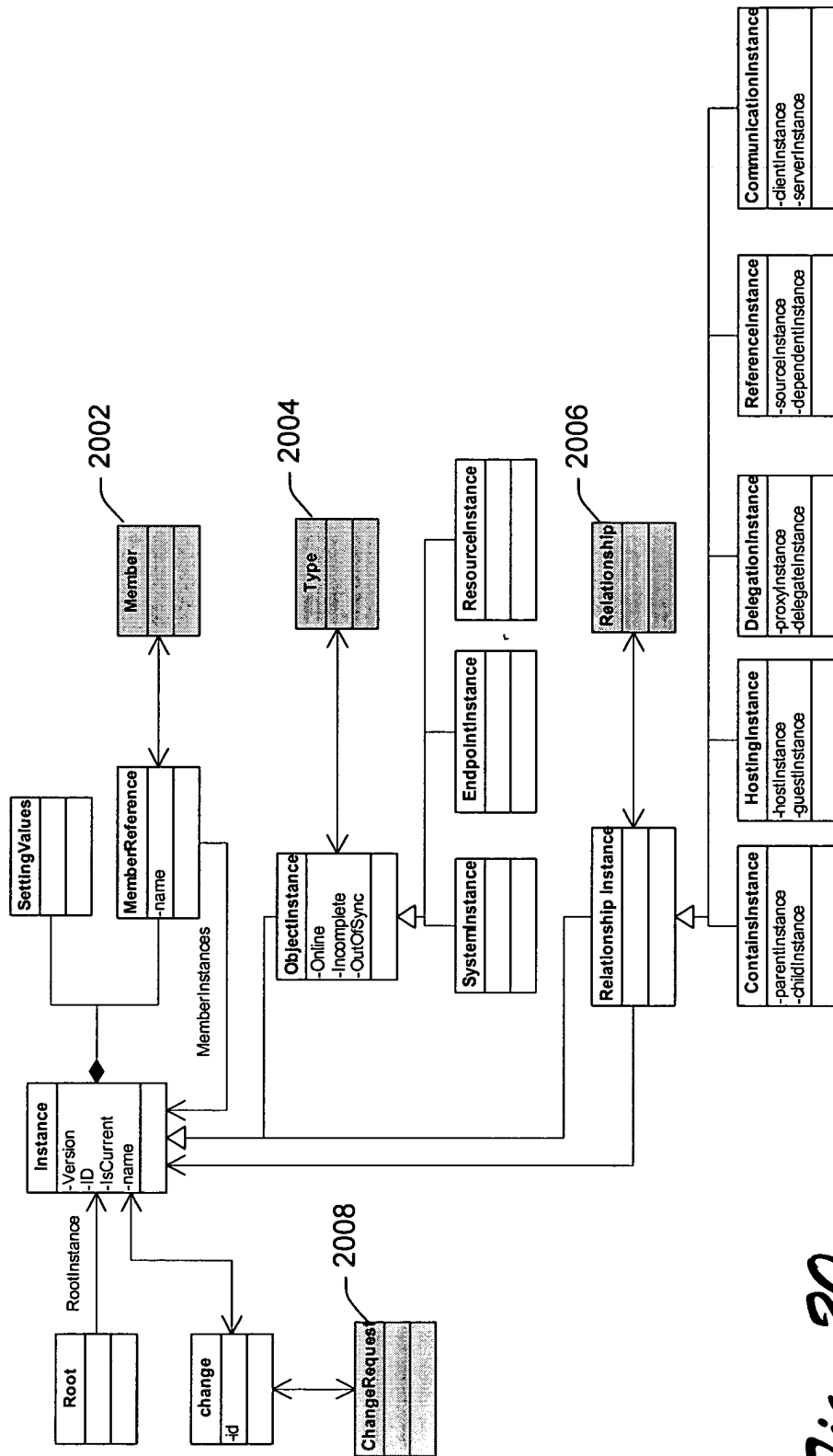

Fig. 20

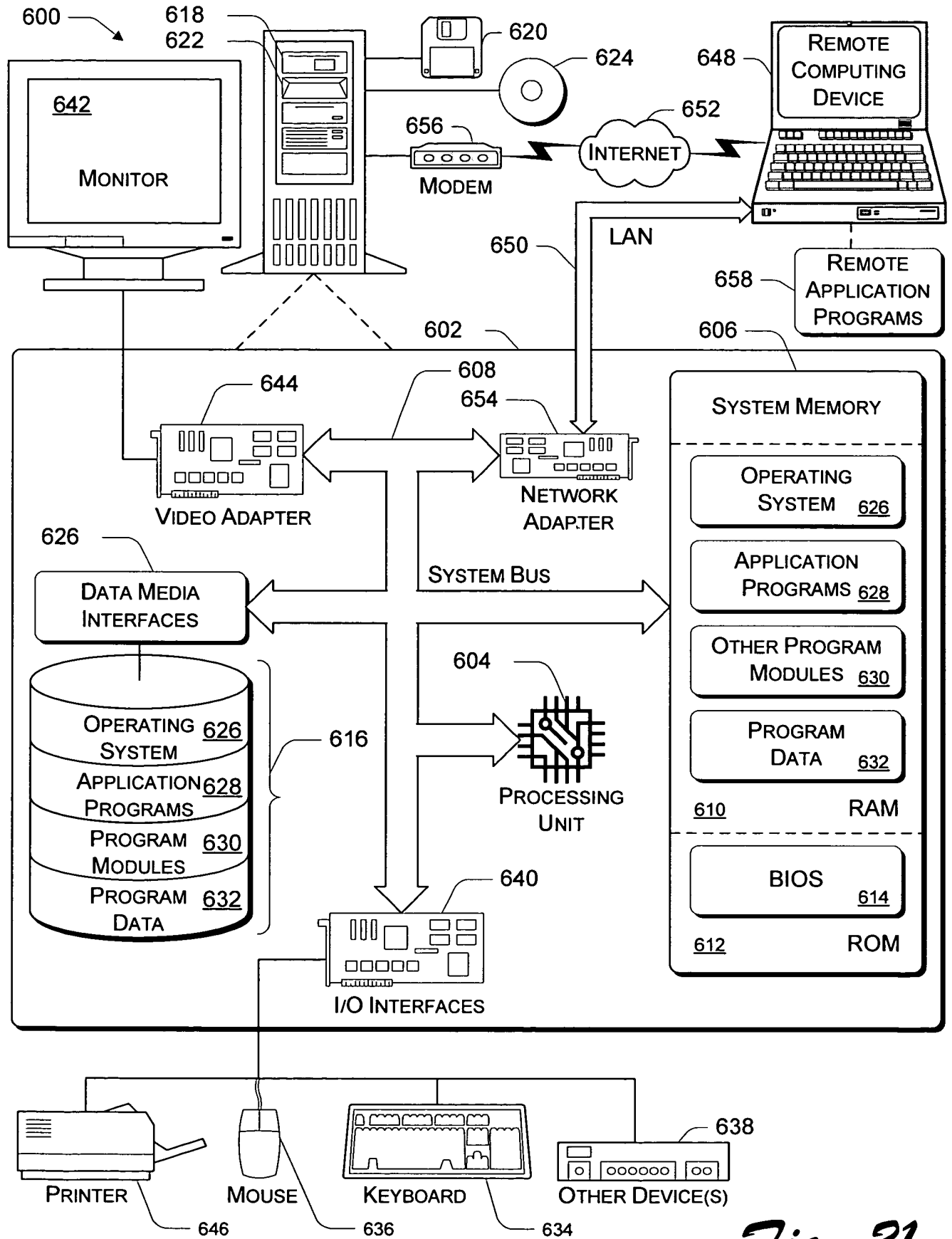

Fig. 21